

Vertical Panel

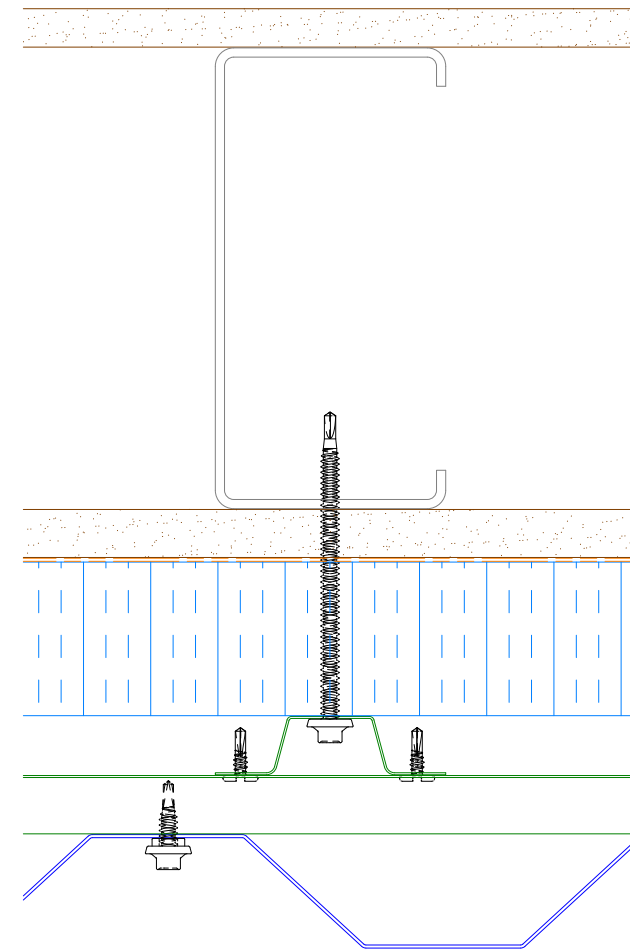

Alternate Subgirt Orientation

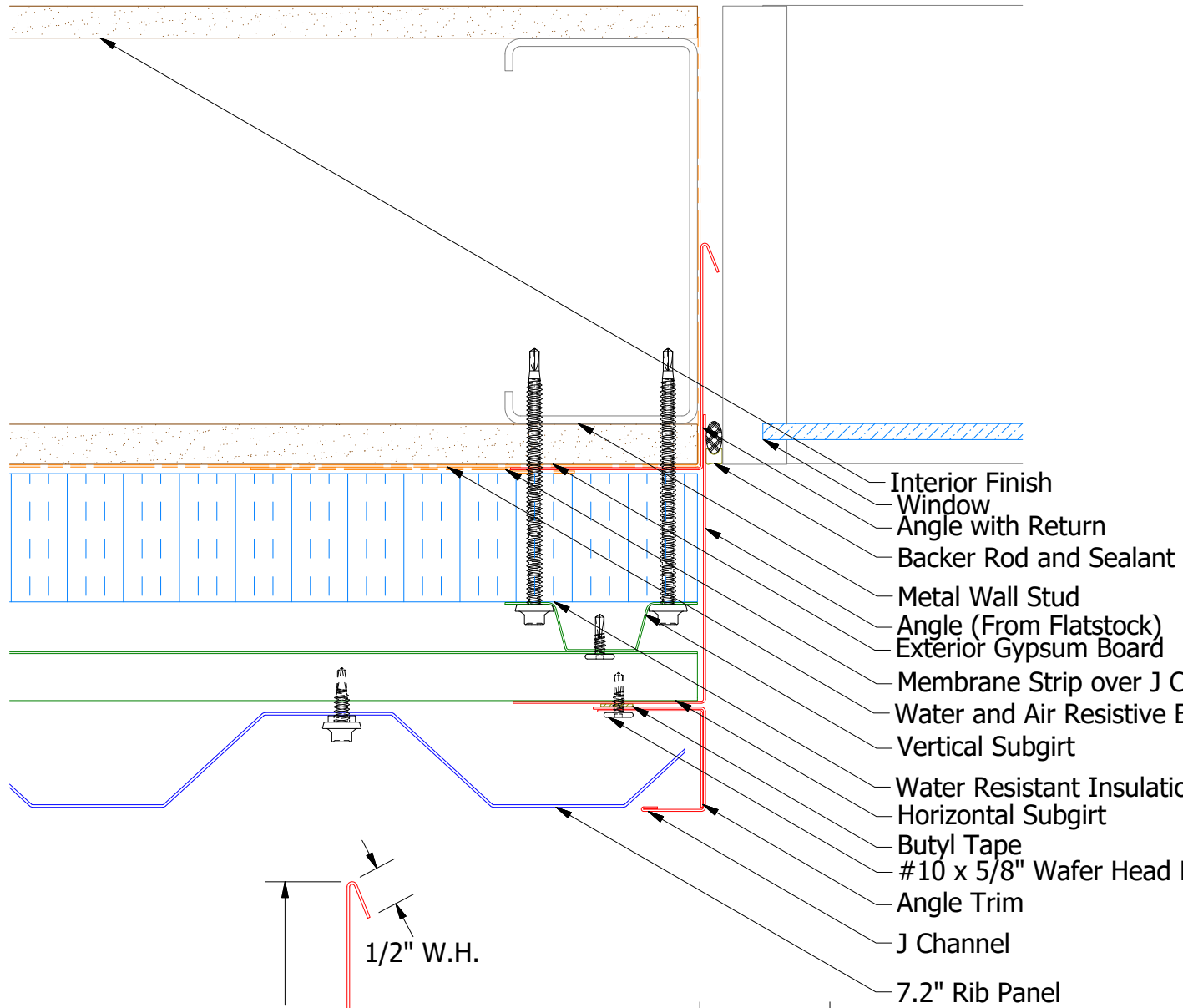
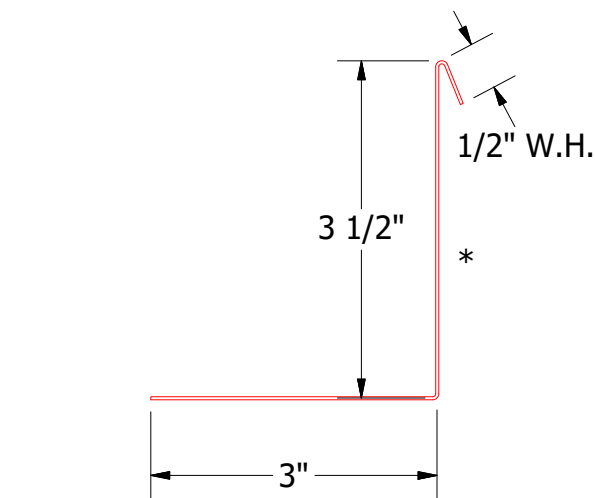
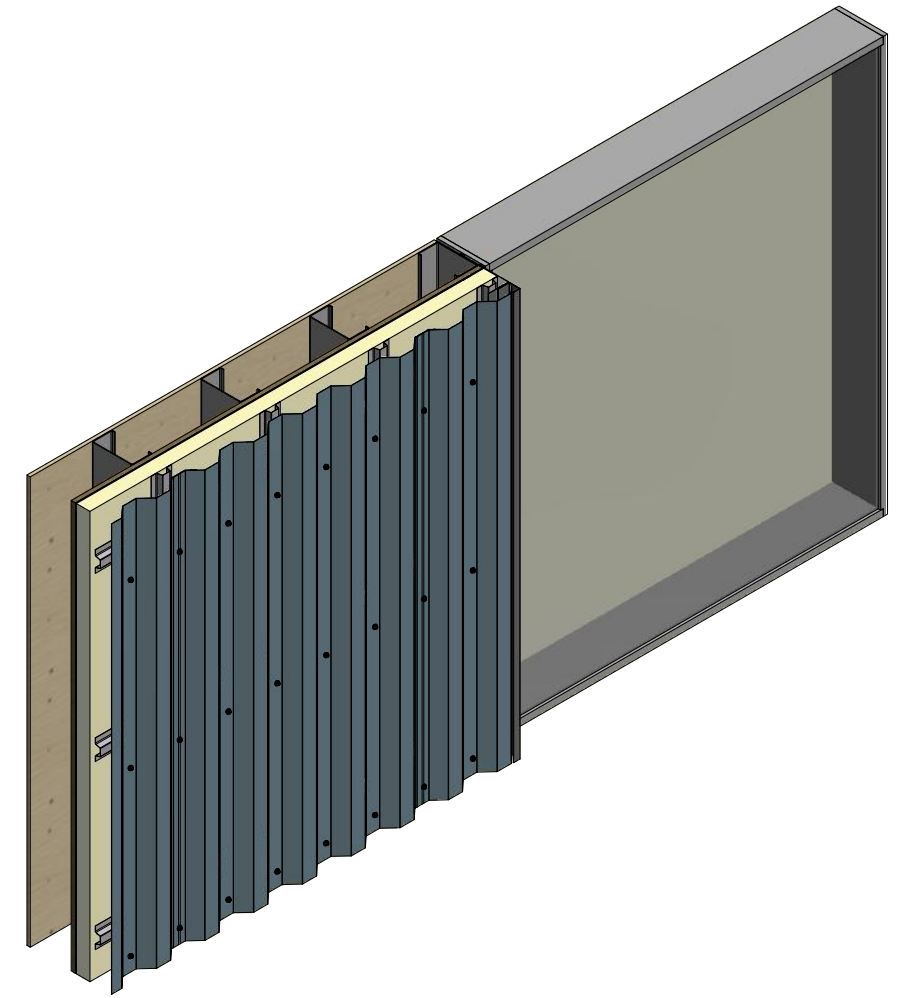

BWA683-Angle with Return

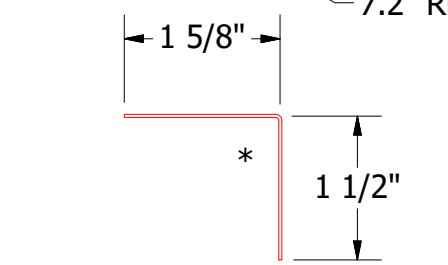

BWA680-Angle Trim

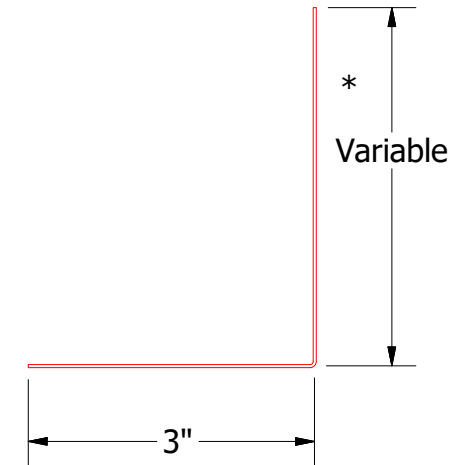

Angle

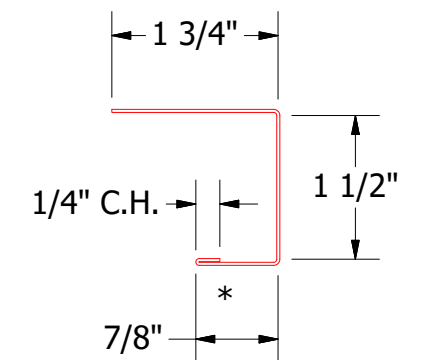

BWA158-J Channel

Note: * denotes color side.

REV. NO.	DATE	DESCRIPTION OF REVISION	BY	APP

TITLE		7.2" Rib Open Jamb Detail		
DWG. NO.	DR	DMR	DATE	8/15/2016
	APP		DATE	
MATERIAL	SH. SIZE	B	SCALE	X:X

ATAS ATAS INTERNATIONAL, INC
 Allentown PA
 610-395-8445
 Mesa AZ
 480-558-7210